

Angular Contact Ball Bearings

72 Series Angular Contact Ball Bearings-7209C

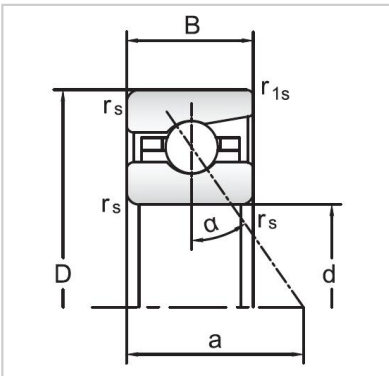

Bearing NO.	7209C
Dimensions(mm)	
d	45
D	85
B	19
ramin	1.1
r1min	0.6
Mounting dimensions	
da min	54
Da/Db max	76
ra max	1.1
rb max	0.6
Loading kN	
Cr	35.5
Cor	33.8
Limited Speed r/min	
Lub.	16000
Oil.	26000
Prelaoding N	
A(L)	187
B(M)	560
C(H)	1120
Axial rigidityRa N/μm	
A(L)	53
B(M)	77
C(H)	97
Weight Kg ≈	0.45