

Ultra High-Speed Angular Contact Ball Bearings

BGR Series Ultra High-Speed Angular Contact Ball Bearings-15BGR02S

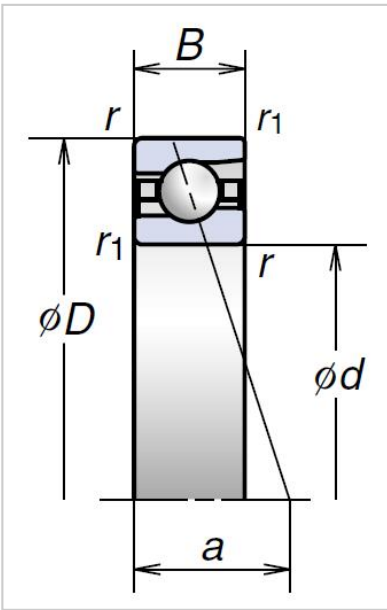

Bearing NO.	15BGR02S
Dimensions	
D (mm)	15
d (mm)	35
2B (mm)	11
r Min	0.6
r1 Min	0.3
Basic Loading Ratings(KN)	
Cr (Dynamic)	5.8
C0r (Static)	2.34
Permissible axial load (KN)	2.9
Effective load center(mm) a	8.8
Limiting speeds [rpm]min-1	
Grease	64000
Oil	88000
Weight (kg)	0.045