

Ultra High-Speed Angular Contact Ball Bearings

BNR Series Ultra High-Speed Angular Contact Ball Bearings-30BNR19H

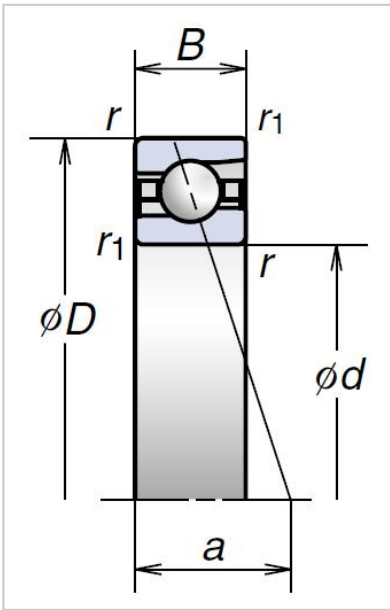

Bearing NO.	30BNR19H
Boundary Dimensions (mm)	
d	30
D	47
B	9
r (min.)	0.3
r1 (min.)	0.15
Basic Load Ratings (kN)	
Cr (Dynamic)	6.3
C0r (Static)	4.05
Permissible Axial Load (1) (kN)	3.8
Effective Load Center (mm) a	10.8
Sealed Design	
Limiting Speeds (2) (min ⁻¹)	
Grease	46800
Oil	72800
Mass (kg)	0.043